



G*GRASS®

**MOVEMENT SYSTEMS
FITTINGS AND ACCESSORIES**



We are where our customers are.
 Because we see customer proximity as
 an expression of our company culture.

G*GRASS®

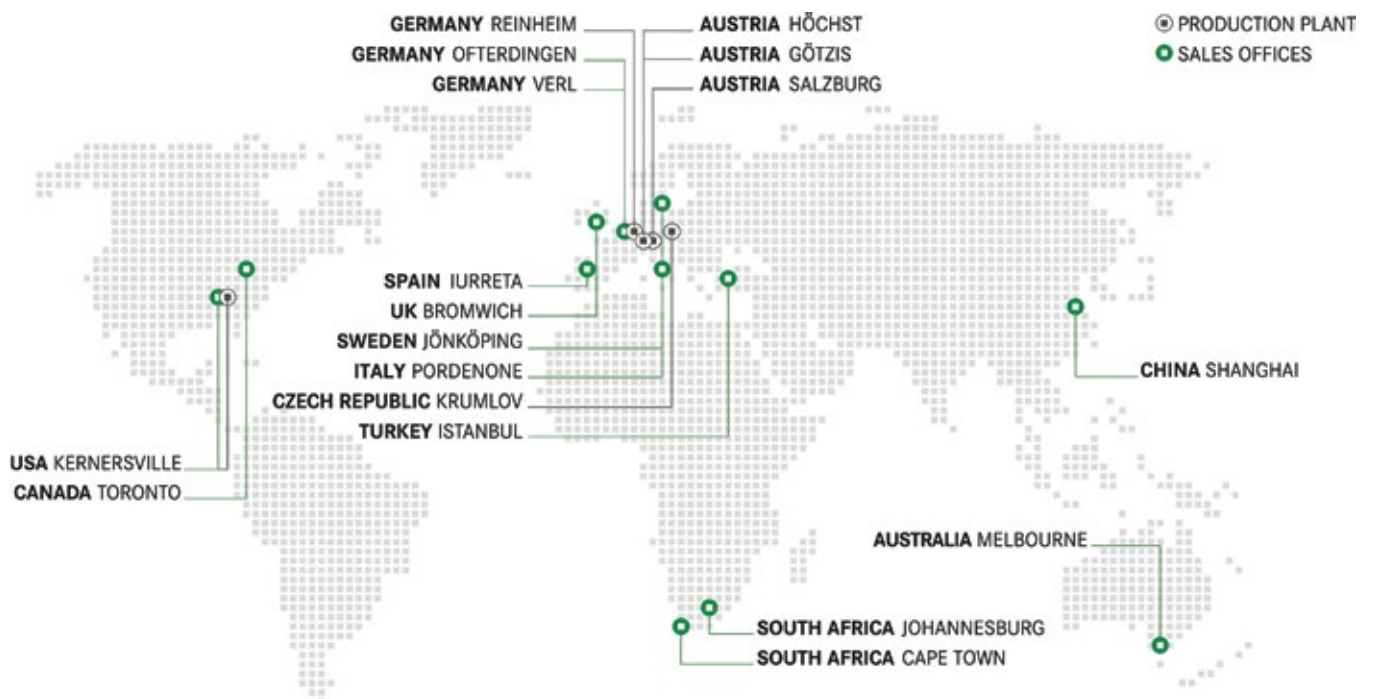



GRASS SOUTH AFRICA.

This catalogue consists of some products not produced by GRASS, but distributed and supplies by GRASS ZA.

G*GRASS®

A globally successful group of companies, a fresh brand with tradition and an extraordinary diversity of perspectives – that’s GRASS in a nutshell. With sales revenues of 391 million euros in the financial year 2019, over 1,900 employees at 18 locations and more than 200 distributors in 60 countries, GRASS ranks among the world’s leading specialists in movement systems.

For further information on GRASS products refer to our International catalogue – www.grass.at



INDEX

PAGE

VIONARO DRAWER SYSTEM	4
NOVA PRO DRAWER SYSTEM	5
DWD XP DRAWER SYSTEM	6
DYNAMOOV/DYNAPRO DRAWER SYSTEM	7
DYNAPRO BASE MOUNT DRAWER SYSTEM	8
INTEGRA DRAWER SYSTEM	9
KINVARO FLAP-UP/FLAP-DOWN SYSTEMS	10 - 11
TIOMOS HIDDEN HINGE	12
TIOMOS M SERIES HINGE	13
TIOMOS HINGE SOFT-CLOSE	14 - 15
NEXIS CLICK-ON HINGE	16 - 17
NEXIS SLIDE-ON HINGE	18 - 19
OMNI CLICK-ON HINGE SOFT-CLOSE	20 - 21
OMNI CLICK-ON/SLIDE-ON HINGE	22 - 23
OMNI SLIDE SYSTEMS	24
CUTLERY INSERTS	25
ORGANISING SYSTEMS - TAVINEA SORTO/TAVINEA OPTIMA	26 - 29
RUBBER MATTING	30
HANDLE PROFILES	31 - 33
DISPLAY WINE SYSTEMS	34 - 37
SIGE LARDER PULL-OUT	38
SIGE PULL-OUT SHELF	39
SIGE ROTATION CORNER	40
SIGE PULL-OUT CORNER	41
SIGE PULL-OUT BASE	42 - 43
SIGE RECYCLE BINS	44 - 45
SIGE WASTE BINS	46
ITALIANA FERRAMENTA PUSH TO OPEN	47
OMNI ACCESSORIES	48 - 50
OMNI KNOCK DOWN FITTINGS	51 - 52



DEPTH	HEIGHT					COLOUR
	63 MM	89 MM	121 MM	185 MM	249 MM	
270	-	■	-	-	-	GRAPHITE
350	-	■	■	■	-	GRAPHITE
400	-	■	■	■	-	GRAPHITE
450	■	■	■	■	■	GRAPHITE
500	■	■	■	■	■	GRAPHITE
550	-	-	■	-	-	GRAPHITE



DEPTH	HEIGHT					COLOUR
	63 MM	89 MM	121 MM	185 MM	249 MM	
270	-	■	-	-	-	WHITE
350	-	■	■	■	-	WHITE
400	-	■	■	■	-	WHITE
450	■	■	■	■	■	WHITE
500	■	■	■	■	■	WHITE
550	-	-	■	-	■	WHITE
600	-	■	-	■	-	WHITE



DEPTH	HEIGHT					COLOUR
	63 MM	89 MM	121 MM	185 MM	249 MM	
400	-	■	-	-	-	SILVER
450	-	■	-	■	-	SILVER
500	-	■	-	■	-	SILVER
550	-	■	-	■	-	SILVER

FEATURES: Slim 13 mm drawer side Tool free front assembly Available in 40 kg and 70 kg
 4D Adjustment Available in 3 colours Fully synchronized slides
 90° straight interior and exterior sides Available in 5 heights Can use same dynapro runner for wooden box and metal sides





DEPTH	HEIGHT					COLOUR
	63 MM	90 MM	122 MM	140 MM	186 MM	
270	-	■	-	-	-	STONE
300	-	■	-	-	■	STONE
350	-	■	-	-	■	STONE
400	■	■	-	-	■	STONE
450	■	■	■	-	■	STONE
500	■	■	■	■	■	STONE
550	-	■	■	-	■	STONE



DEPTH	HEIGHT					COLOUR
	63 MM	90 MM	122 MM	140 MM	186 MM	
270	-	■	-	-	-	WHITE
300	-	■	-	-	■	WHITE
350	-	■	-	-	■	WHITE
400	■	■	-	-	■	WHITE
450	■	■	■	-	■	WHITE
500	■	■	■	■	■	WHITE
550	-	■	■	-	■	WHITE



DEPTH	HEIGHT					COLOUR
	63 MM	90 MM	122 MM	140 MM	186 MM	
270	-	■	-	-	-	SILVER
350	-	■	-	-	-	SILVER
400	-	■	-	-	-	SILVER
450	-	■	-	-	-	SILVER
500	-	■	-	■	■	SILVER

FEATURES: Double wall drawer
 Can be personalised with designer panels
 Intergrated height and side adjustment
 Robust design and high level of stability

Optimum use of space due to straight inside surfaces and low construction width
 Tool free installation and removal of drawer front
 Width of bottom and back panel is the same

Available in 40 kg & 70 kg
 Fully synchronised slides
 Compatible with Tavinea Sorto





DRAWER TYPE	DRAWER LENGTH NL	COLOUR
DWD XP H95	275	GREY
	400	GREY
	450	GREY
	500	GREY
RAILSET ROUND	400	GREY
	450	GREY
	500	GREY
RAILSET SQUARE	450	GREY
	500	GREY



DRAWER TYPE	DRAWER LENGTH NL	COLOUR
DWD XP H95	275	WHITE
	400	WHITE
	450	WHITE
	500	WHITE
RAILSET SQUARE	400	WHITE
	450	WHITE
	500	WHITE

FEATURES: Double wall drawer
40 kg + 60 kg
2D Adjustment

Fully synchronised
Full extension
Width of bottom and back panel is the same

Compatible with Tavinea Sorto





DRAWER TYPE	DRAWER LENGTH NL	CODE	+	ADD
				1D LOCKING DEVICE
DYNAMOOV SOFT-CLOSE 30 KG	270	F130107761211		F134101220
	300	F130107764211		F134101220
	350	F130107768211		F134101220
	400	F130107772211		F134101220
	450	F120107776210		F134101220
	500	F130107780210		F134101220
	550	F130107784210		F134101220

DRAWER TYPE	DRAWER LENGTH NL	CODE	+	ADD
				D LOCKING DEVICE
DYNAMOOV TIPMATIC 30 KG	300	F130101115211		F134101220
	350	F130101117211		F134101220
	400	F130101119211		F134101220
	450	F130101121210		F134101220
	500	F130101123210		F134101220
	550	F130101125210		F134101220

DRAWER TYPE	DRAWER LENGTH NL	CODE	+	ADD
				2D LOCKING DEVICE
DYNAPRO SOFT-CLOSE 40 KG	300	F130107796204		F134117193
	350	F130107802204		F134117193
	400	F130107808204		F134117193
	450	F130107814204		F134117193
	500	F130107820204		F134117193
	550	F130107826204		F134117193
DYNAPRO SOFT-CLOSE 70 KG	500	F130107838204		F134117193
TIPMATIC SOFT-CLOSE ADD-ON	SYNC ROD	F134109410207		
	ACTIVATOR	F134109323607		

FEATURES: Undermount slide 30 kg, 40 kg and 70 kg options 2D, 3D and 4D Adjustment options Fully synchronised Full extension Minimum drawer deflection Dynapro can be used with vionaro steel sides



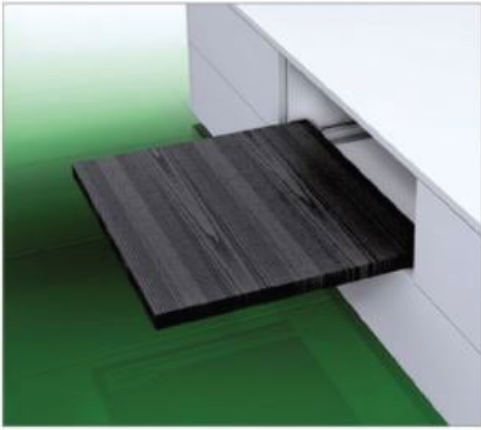

DRAWER LENGTH	CODE	+	ADD
			SHELF CLIP SET
BASE MOUNT FULL EXTENSION 450 MM	F130107884210		F134107411517
BASE MOUNT FULL EXTENSION 500 MM	F130107890210		F134107411517

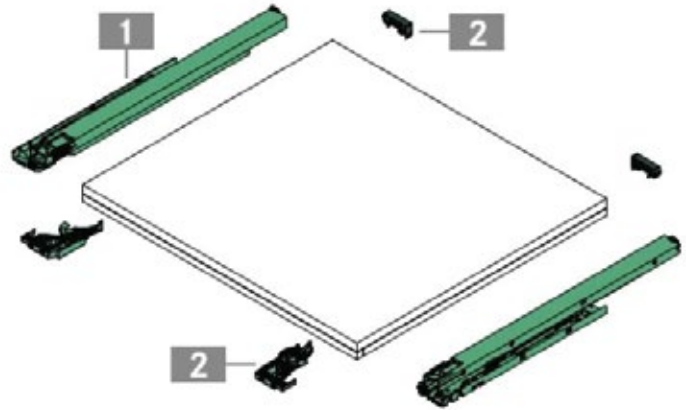

FEATURES: Undermount base mount slide Assembly on cabinet base
 Full extension 40 kg load capacity Height adjustment + 3.5 m
 Soft-close



53 MM DRAWER



DRAWER TYPE	DRAWER LENGTH NL	CODE	ADD	ADD	ADD
			LEFT BRACKET	RIGHT BRACKET	COVER CAP
INTEGRA H-53	450	F084074926207	F084115209236	F084115210236	-
	500	F084074917207	F084115209236	F084115210236	-

85 MM DRAWER



DRAWER TYPE	DRAWER LENGTH NL	CODE	ADD	ADD	ADD
			LEFT BRACKET	RIGHT BRACKET	COVER CAP X2
INTEGRA H-85	275	F084074972207	F084115231236	F084115233236	F084075011240
	350	F084074952207	F084115231236	F084115233236	F084075011240
	400	F084074959207	F084115231236	F084115233236	F084075011240
	450	F084074960207	F084115231236	F084115233236	F084075011240
	500	F084074961207	F084115231236	F084115233236	F084075011240
	550	F084074968207	F084115231236	F084115233236	F084075011240

149 MM DRAWER



DRAWER TYPE	DRAWER LENGTH NL	CODE	ADD	ADD	ADD
			LEFT BRACKET	RIGHT BRACKET	COVER CAP X2
INTEGRA H-149	450	F084075168204	F084115231236	F084115233236	F084075011240
	500	F084075170204	F084115231236	F084115233236	F084075011240

RAIL SETS

TYPE	SIZE	CODE
INTEGRA POT RAIL SET	500	3500.500.2
INTEGRA FILING RAIL	500	F084074850511



FEATURES: Single wall drawer
30 kg
2D Adjustments





FLAP TYPE	MIN HEIGHT	MAX HEIGHT	RANGE OF FLAP	CODE
KINVARO T-65	200	300	Width: Up to 1200 mm	F15114779201
KINVARO T-70	300	400	Width: Up to 1200 mm	F151147693201
KINVARO T-75	400	600	Width: Up to 1200 mm	F151147700201



FLAP TYPE	MIN HEIGHT	MAX HEIGHT	RANGE OF FLAP	CODE
KINVARO F-20	600	900	Width: 450 mm-1200 mm	
TYPE 4B	600	649	Weight: 4.1 kg - 12.1kg	F152147675201
TYPE 4C	600	649	Weight: 6.8 kg - 15.8 kg	F152147842201
TYPE 5B	650	699	Weight: 3.8 kg - 11.4 kg	F152147840201
TYPE 6C	700	749	Weight: 6.5 kg - 16.4 kg	F152147844201
TYPE 6D	700	749	Weight: 10.0 kg - 18.0 kg	F152147846201
TYPE 7C	750	799	Weight: 6.0 kg - 15.6 kg	F152147787201
TYPE 7D	750	900	Weight: 6.5 kg - 16.5 kg	F152147847201



FLAP TYPE	MIN HEIGHT	MAX HEIGHT	RANGE OF FLAP	CODE
KINVARO S-35	420	750	Width: 450 mm-1200 mm	
SPRING A	420	719	Weight: 1.5 kg - 7.5 kg	F152147818201
SPRING B	420	629	Weight: 5.0 kg - 11.0 kg	F152147819201
SPRING C	540	750	Weight: 4.0 kg - 14.0 kg	F152147820201
SPRING D	570	750	Weight: 6.5 kg - 16.0 kg	F152147821201



FLAP TYPE	MIN HEIGHT	MAX HEIGHT	RANGE OF FLAP	CODE
KINVARO L-80	350	600	Width: 450 mm-1200 mm	
TYPE 1A	350	369	Weight: 2.5 kg - 6.5 kg	F152147781201
TYPE 2A	370	389	Weight: 2.3 kg - 6.0 kg	F152147824201
TYPE 3A	390	409	Weight: 2.1 kg - 5.5 kg	F152147825201
TYPE 5B	430	600	Weight: 4.0 kg - 7.5 kg	F152147715201
TYPE 5C	430	600	Weight: 7.0 kg - 14.6 kg	F152147836201

HOW TO CALCULATE YOUR DOOR WEIGHT:

FLAP WIDTH X FLAP HEIGHT X FLAP THICKNESS X DENSITY + HANDLE = WEIGHT OF FLAP
 DENSITIES: MDF 0.85KG, CHIPBOARD 0.65KG, PINE 0.45KG
 FOR BAR HANDLES, ALLOW 0.1KG FOR EACH 100 MM HANDLE WIDTH

LIFTS COME WITH ADJUSTABLE DAMPING/ SOFT-CLOSE SYSTEM

WE RECOMMEND A TRIAL FIT BEFORE FINAL INSTALLATION



FLAP TYPE	MIN HEIGHT	MAX HEIGHT	MAX WEIGHT	CODE
KINVARO D-S WHITE 40N	200	480	3 KG	F053139664607
KINVARO D-S NIGHT 40N	200	480	3 KG	F053139665607
KINVARO D-S WHITE 60N	200	480	6 KG	F053139666607
KINVARO D-S NIGHT 60N	200	480	6 KG	F053139667607
KINVARO D-M WHITE 100N	200	480	10 KG	F053139662607 WH
KINVARO D-M NIGHT 100N	200	480	10 KG	F053139662607 N



DESCRIPTION	APPLICATION	CODE	PACK SIZE
TIOMOS FLAP HINGE NICKEL	OVERLAY 90°	F053139671	EACH
TIOMOS FLAP HINGE NIGHT	OVERLAY 90°	F053139677	EACH

DRILLING PATTERNS

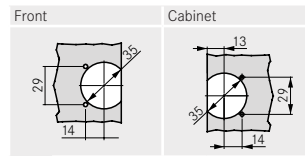

CUP DIMENSIONS

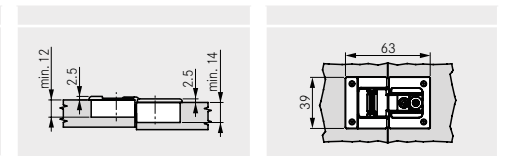

- FEATURES:**
- Modern design
 - 90° opening angle
 - For flap thicknesses of up to 21 mm
 - Narrow gaps between door and cabinet
 - Large overlay of up to 19 mm
 - 12 mm cup depth
 - 3 Dimensional adjustment
 - Very suitable for combining with the Kinvaro D flap stays



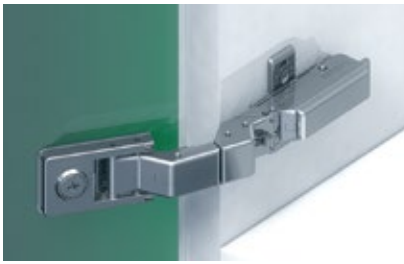

DESCRIPTION	APPLICATION	CODE	PACK SIZE
TIOMOS MIRROR/CLEAR GLASS HINGE	MIRROR OR CLEAR GLASS	F029140325	EACH
ECO CROSS 0 MM M/PLATE	-	F058139721217	EACH
ZAMAK ADAPTER FOR CLEAR GLASS	CLEAR GLASS	F072135868	EACH
STAINLESS STEEL ADAPTER FOR MIRROR	MIRROR	F069073731217	EACH

FEATURES: 125° opening angle
 Fastening through door-side gluing of Zamak adapter
 Connection of the hinge to the adapter using a cam

Quick final assembly without glass drilling
 High overlay up to 19 mm



DESCRIPTION	APPLICATION	CODE	PACK SIZE
TIOMOS M9 HINGE 110°	DOOR THICKNESS FROM 12-28 MM	F029140334	EACH
ECO CROSS 0 MM M/PLATE	-	F058139721217	EACH

FEATURES: For door thicknesses up to max. 28 mm
 35 mm full cup drilled hole
 Low cup depth of 9 mm
 For mitred door applications

For rebate door applications
 3-dimensional adjustment with appropriate mounting plate
 For door overlays up to 25 mm



DESCRIPTION	APPLICATION	CODE	PACK SIZE
TIOMOS M0 HINGE 125°	DOOR THICKNESS 6-10 MM	F029140331217	EACH
ECO CROSS 0 MM M/PLATE	-	F058139721217	EACH

FEATURES: For door thicknesses for 6 - 10 mm
 No cup hole necessary
 3-dimensional adjustment
 For door overlays of up to 25 mm

Compatible with all mounting plates
 Zero protusion up to 14 mm overlay
 125° opening angle





DESCRIPTION	APPLICATION	CODE	PACK SIZE
TIOMOS HINGE DOWEL SOFT-CLOSE	OVERLAY 110°	F028138098228	150
TIOMOS HINGE DOWEL SOFT-CLOSE	HALF OVERLAY 110°	F028138099228	150
TIOMOS HINGE DOWEL SOFT-CLOSE	INSET OVERLAY 110°	F028138100217	150

FEATURES: Door thickness up to 24 mm
 Dept adjustment via worm gear
 3D Adjustment with appropriate mounting plates

Adjustable soft-close
 12.6 mm Cup depth



DESCRIPTION	APPLICATION	CODE	PACK SIZE
TIOMOS HINGE DOWEL SOFT-CLOSE	INSET 110/45° CORNER	F028138118223	50

FEATURES: For 45° angled cabinets
 110° Opening angle
 3D Adjustment



DESCRIPTION	APPLICATION	CODE	PACK SIZE
TIOMOS HINGE DOWEL SOFT-CLOSE	INSET 90 MM POST HINGE	F028138120213	50

FEATURES: For blind corner applications
 110° Opening angle
 3D Adjustment



DESCRIPTION	APPLICATION	CODE	PACK SIZE
TIOMOS HINGE DOWEL SOFT-CLOSE	OVERLAY 160° MBP	F028138139217	50
TIOMOS HINGE DOWEL SOFT-CLOSE	HALF OVERLAY 160° MBP	F028138140213	50

FEATURES: 160° Opening angle
 Zero protrusion
 Shallow cup depth of 10 mm

Door thickness up to 32 mm
 3D Adjustment



DESCRIPTION	APPLICATION	CODE	PACK SIZE
TIOMOS HINGE DOWEL NON SOFT-CLOSE	PIE-CUT/BI-FOLD	F045138092	50

FEATURES: For connecting 2 cabinet doors
 Shallow cup depth 11.8 mm
 3D Adjustment

24 mm Max door thickness
 No soft-close



DESCRIPTION	APPLICATION	CODE	PACK SIZE
HINGES HINGE DOWEL SOFT-CLOSE	OVERLAY 110° NIGHT	F028139132228	EACH
HINGES HINGE SOFT-CLOSE	OVERLAY 110° 20/20 NIGHT	F028140404228	EACH
TIOMOS MOUNTING PLATE	1D LINEAR SCREW FIX 3 MM NIGHT	F059139979228	EACH
TIOMOS HINGE ARM COVER	ARM COVER NIGHT	F072140519228	EACH
TIOMOS HINGE CUP COVER	CUP COVER NIGHT	F072140520228	EACH



DESCRIPTION	APPLICATION	CODE	PACK SIZE
TIOMOS MOUNTING PLATE	ECO CROSS SCREW FIX - 2 MM	F058139720228	150
TIOMOS MOUNTING PLATE	ECO CROSS SCREW FIX 0 MM	F058139721217	150
TIOMOS MOUNTING PLATE	ECO CROSS SCREW FIX 3 MM	F058139723228	150
TIOMOS MOUNTING PLATE	ECO CROSS MOUNTED EURO FIX - 2 MM	F058139735228	150
TIOMOS MOUNTING PLATE	ECO CROSS MOUNTED EURO FIX 0 MM	F058139736228	150
TIOMOS MOUNTING PLATE	ECO CROSS MOUNTED EURO FIX 3 MM	F058139738228	150



DESCRIPTION	APPLICATION	CODE	PACK SIZE
TIOMOS MOUNTING PLATE	1D SCREW FIX 0 MM	F058139746217	150
TIOMOS MOUNTING PLATE	1D SCREW FIX 3 MM	F058139748217	150
TIOMOS MOUNTING PLATE	1D SCREW FIX 6 MM	F058139892217	150
TIOMOS MOUNTING PLATE	1D MOUNTED EURO SCREW 3 MM	F058139763217	150
TIOMOS MOUNTING PLATE	1D MOUNTED EURO SCREW 6 MM	F058139873217	150



DESCRIPTION	APPLICATION	CODE	PACK SIZE
TIOMOS MOUNTING PLATE	1D LINEAR SCREW FIX 0 MM	F058139701217	150
TIOMOS MOUNTING PLATE	1D LINEAR SCREW FIX 3 MM	F058139703217	150
TIOMOS MOUNTING PLATE	1D LINEAR DOWEL FIX 3 MM	F058139708228	150
TIOMOS MOUNTING PLATE	1D LINEAR EURO FIX 3 MM	F058139713228	150

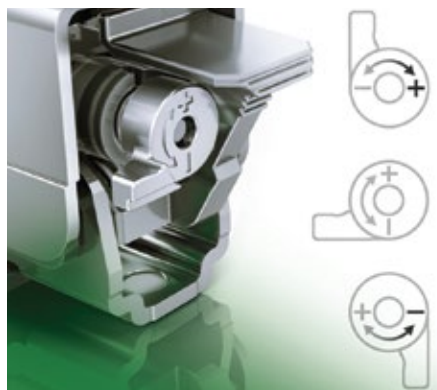



DESCRIPTION	APPLICATION	CODE	PACK SIZE
NEXIS HINGE CLICK-ON SCREW-IN	FULL OVERLAY 100°	F015072722236	250
NEXIS HINGE CLICK-ON DOWEL	FULL OVERLAY 100°	F015072719236	250

FEATURES: Door thickness up to 24 mm
 Cup depth 11 mm
 Clip on with various plate options
 Soft-close compatible
 3 Dimensional adjustment with appropriate plate



DESCRIPTION	APPLICATION	CODE	PACK SIZE
NEXIS HINGE CLICK-ON SCREW-IN	HALF OVERLAY 100°	F015072729236	250
NEXIS HINGE CLICK-ON DOWEL	HALF OVERLAY 100°	F015072727236	250

FEATURES: Door thickness up to 24 mm
 Cup depth 11 mm
 Clip on with various plate options
 Soft-close compatible
 3 Dimensional adjustment with appropriate plate



DESCRIPTION	APPLICATION	CODE	PACK SIZE
NEXIS HINGE CLICK-ON SCREW-IN	INSET 100°	F015072736236	250
NEXIS HINGE CLICK-ON DOWEL	INSET 100°	F015072732236	250

FEATURES: Door thickness up to 24 mm
 Cup depth 11 mm
 Clip on with various plate options
 Soft-close compatible
 3 Dimensional adjustment with appropriate plate



DESCRIPTION	APPLICATION	CODE	PACK SIZE
NEXIS HINGE CLICK-ON SCREW-IN	INSET 45° CORNER	F015072751225	125
NEXIS HINGE CLICK-ON DOWEL	INSET 45° CORNER	F015072750225	125

FEATURES: Door thickness up to 30 mm
 Cup depth 11.8 mm
 Clip on with various plate options
 Soft-close compatible
 3 Dimensional adjustment with appropriate plate
 95° Opening angle



DESCRIPTION	APPLICATION	CODE	PACK SIZE
NEXIS HINGE CLICK-ON SCREW-IN	INSET 83 MM POST/BLIND CORNER	F015072788225	125
NEXIS HINGE CLICK-ON DOWEL	INSET 83 MM POST/BLIND CORNER	F015072787225	125

FEATURES: Door thickness up to 30 mm
 Cup depth 11.8 mm
 Clip on with various plate options
 Soft-close compatible
 3 Dimensional adjustment with appropriate plate
 95° Opening angle



DESCRIPTION	APPLICATION	CODE	PACK SIZE
NEXIS HINGE CLICK-ON SCREW-IN	FULL OVERLAY 170°	F015072842217	50
NEXIS HINGE CLICK-ON DOWEL	FULL OVERLAY 170°	F015072840217	50

FEATURES: Door thickness up to 26 mm
 Cup depth 11 mm
 Clip on with various plate options
 Soft-close compatible
 3 Dimensional adjustment with appropriate plate
 Zero protusion hinge at 90° opening angle



DESCRIPTION	APPLICATION	CODE	PACK SIZE
NEXIS CLICK-ON CROSS M/PLATE	SCREW FIX 2 MM	F060073145236	250



DESCRIPTION	APPLICATION	CODE	PACK SIZE
NEXIS CLICK-ON CROSS M/PLATE	MOUNTED EURO SCREW 2 MM	F060073180236	250



DESCRIPTION	APPLICATION	CODE	PACK SIZE
NEXIS HINGE	SOFT-CLOSE ADAPTER	F069073715225	125



DESCRIPTION	CODE	SIZE	FINISH
KPUSH TECH WITH BUFFER STRONG	57008080AB	70 MM	WHITE
MOUNTING PLATE WITH HOUSING	57010040	80 MM	WHITE
KPUSH TECH WITH BUFFER STRONG	57008080EE	70 MM	GRAPHITE
MOUNTING PLATE WITH HOUSING	57010040G	80 MM	GRAPHITE



DESCRIPTION	APPLICATION	CODE	PACK SIZE
NEXIS HINGE SLIDE-ON SCREW-IN	FULL OVERLAY 100°	F016073008236	250
NEXIS HINGE SLIDE-ON DOWEL	FULL OVERLAY 100°	F016073010236	250

FEATURES: Door thickness up to 24 mm
 Cup depth 11 mm
 Slide on with various plate options
 Soft-dose compatible
 3 Dimensional adjustment with appropriate plate



DESCRIPTION	APPLICATION	CODE	PACK SIZE
NEXIS HINGE SLIDE-ON SCREW-IN	HALF OVERLAY 100°	F016073014236	250
NEXIS HINGE SLIDE-ON DOWEL	HALF OVERLAY 100°	F016073016236	250

FEATURES: Door thickness up to 24 mm
 Cup depth 11 mm
 Slide on with various plate options
 Soft-close compatible
 3 Dimensional adjustment with appropriate plate



DESCRIPTION	APPLICATION	CODE	PACK SIZE
NEXIS HINGE SLIDE-ON SCREW-IN	INSET 100°	F016073018236	250
NEXIS HINGE SLIDE-ON DOWEL	INSET 100°	F016073020236	250

FEATURES: Door thickness up to 24 mm
 Cup depth 11 mm
 Slide on with various plate options
 Soft-close compatible
 3 Dimensional adjustment with appropriate plate



DESCRIPTION	APPLICATION	CODE	PACK SIZE
NEXIS HINGE SLIDE-ON SCREW-IN	INSET 45° CORNER	F016073033225	125
NEXIS HINGE SLIDE-ON DOWEL	INSET 45° CORNER	454.405.54.0315	125

FEATURES: Door thickness up to 30 mm
 Cup depth 11.8 mm
 Slide on with various plate options
 Soft-close compatible
 3 Dimensional adjustment with appropriate plate
 95° Opening Angle



DESCRIPTION	APPLICATION	CODE	PACK SIZE
NEXIS HINGE SLIDE-ON SCREW-IN	63 MM INSET/BLIND-CORNER	F016073048225	125
NEXIS HINGE SLIDE-ON DOWEL	63 MM INSET/BLIND-CORNER	456.405.54.9615	125

FEATURES: Door thickness up to 30 mm
 Cup depth 11.8 mm
 Slide on with various plate options
 Soft-close compatible
 3 Dimensional adjustment with appropriate plate
 95° Opening Angle



DESCRIPTION	APPLICATION	CODE	PACK SIZE
NEXIS HINGE SLIDE-ON SCREW-IN	FULL OVERLAY 170°	F016073077217	50
NEXIS HINGE SLIDE-ON DOWEL	FULL OVERLAY 170°	F016073078217	50

FEATURES: Door thickness up to 26 mm
 Cup depth 11 mm
 Slide on with various plate options
 Soft-close compatible
 3 Dimensional adjustment with appropriate plate
 Zero protrusion hinge at 90° opening



DESCRIPTION	APPLICATION	CODE	PACK SIZE
NEXIS SLIDE-ON M/PLATE	SCREW FIX - 0 MM	F062073298236	250



DESCRIPTION	APPLICATION	CODE	PACK SIZE
NEXIS SLIDE-ON M/PLATE	MOUNTED EURO SCREW - 0 MM	F062073316236	250

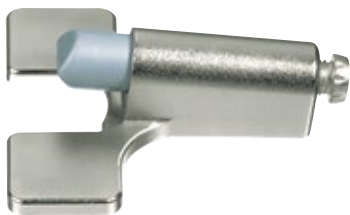

DESCRIPTION	APPLICATION	CODE	PACK SIZE
NEXIS HINGE	SOFT-CLOSE ADAPTER	F069073715225	125



DESCRIPTION	CODE	SIZE	FINISH
KPUSH TECH WITH BUFFER STRONG	57008080AB	70 MM	WHITE
MOUNTING PLATE WITH HOUSING	57010040	80 MM	WHITE
KPUSH TECH WITH BUFFER STRONG	57008080EE	70 MM	GRAPHITE
MOUNTING PLATE WITH HOUSING	57010040G	80 MM	GRAPHITE



DESCRIPTION	APPLICATION	CODE	PACK SIZE
OMNI HINGE CLICK-ON SCREW-IN	FULL OVERLAY SOFT-CLOSE 110°	A36A07	200
OMNI HINGE CLICK-ON DOWEL	FULL OVERLAY SOFT-CLOSE 110°	A36A07N	200

FEATURES: Door thickness up to 16 mm
Cup depth 11.3 mm
Clip on with various plate options



DESCRIPTION	APPLICATION	CODE	PACK SIZE
OMNI HINGE CLICK-ON SCREW-IN	HALF OVERLAY SOFT-CLOSE 110°	A36A03	200
OMNI HINGE CLICK-ON DOWEL	HALF OVERLAY SOFT-CLOSE 110°	A36A03N	200

FEATURES: Door thickness up to 16 mm
Cup depth 11.3 mm
Clip on with various plate options



DESCRIPTION	APPLICATION	CODE	PACK SIZE
OMNI HINGE CLICK-ON SCREW-IN	INSET SOFT-CLOSE 110°	A36A01	200
OMNI HINGE CLICK-ON DOWEL	INSET SOFT-CLOSE 110°	A36A01N	200

FEATURES: Door thickness up to 16 mm
Cup depth 11.3 mm
Clip on with various plate options



DESCRIPTION	APPLICATION	CODE	PACK SIZE
OMNI HINGE CLICK-ON SCREW-IN	INSET SOFT-CLOSE 45°	AC12T02	100
OMNI HINGE CLICK-ON DOWEL	INSET SOFT-CLOSE 45°	AC12T02N	100

FEATURES: Door thickness up to 16 mm
Cup depth 11.3 mm
Clip on with various plate options



DESCRIPTION	APPLICATION	CODE	PACK SIZE
OMNI HINGE CLICK-ON SCREW-IN	INSET POST HINGE SOFT-CLOSE 110°	A1203	100
OMNI HINGE CLICK-ON DOWEL	INSET POST HINGE SOFT-CLOSE 110°	A1203N	100

FEATURES: Door thickness up to 16 mm
Cup depth 11.3 mm
Clip on with various plate options



DESCRIPTION	APPLICATION	CODE	PACK SIZE
OMNI HINGE CLICK-ON SCREW-IN	FULL OVERLAY SOFT-CLOSE 165°	AC2016	100
OMNI HINGE CLICK-ON DOWEL	FULL OVERLAY SOFT-CLOSE 165°	AC2016N	100

FEATURES: Door thickness up to 16 mm
 Cup depth 11.3 mm
 Clip on with various plate options



DESCRIPTION	APPLICATION	CODE	PACK SIZE
OMNI M/PLATE CLICK-ON	SCREW FIX - 0 MM	C31HO-4HOLE	500



DESCRIPTION	APPLICATION	CODE	PACK SIZE
OMNI M/PLATE CLICK-ON	10 MM MOUNTED EURO SCREW - 0 MM	C31H0D-10	500



DESCRIPTION	APPLICATION	CODE	PACK SIZE
OMNI M/PLATE CLICK-ON	13 MM MOUNTED EURO SCREW - 0 MM	C31H0D-13	500



DESCRIPTION	APPLICATION	CODE	PACK SIZE
OMNI M/PLATE CLICK-ON	SCREW FIX - ID	C31CAMHO	500



DESCRIPTION	APPLICATION	CODE	PACK SIZE
OMNI HINGE CLICK-ON SCREW IN	FULL OVERLAY 110°	C0406	250
OMNI HINGE CLICK-ON DOWEL	FULL OVERLAY 110°	C0406N	250

FEATURES: Door thickness up to 16 mm
Cup depth 11.3 mm
Clip on with various plate options



DESCRIPTION	APPLICATION	CODE	PACK SIZE
OMNI HINGE CLICK-ON SCREW IN	HALF OVERLAY 110°	C0403	250
OMNI HINGE CLICK-ON DOWEL	HALF OVERLAY 110°	C0403N	250

FEATURES: Door thickness up to 16 mm
Cup depth 11.3 mm
Clip on with various plate options



DESCRIPTION	APPLICATION	CODE	PACK SIZE
OMNI HINGE CLICK-ON SCREW IN	INSET 110°	C0401	250
OMNI HINGE CLICK-ON DOWEL	INSET 110°	C0401N	250

FEATURES: Door thickness up to 16 mm
Cup depth 11.3 mm
Clip on with various plate options



DESCRIPTION	APPLICATION	CODE	PACK SIZE
OMNI HINGE CLICK-ON SCREW IN	INSET 45° CORNER	C12T02	100
OMNI HINGE CLICK-ON DOWEL	INSET 45° CORNER	C12T02N	100

FEATURES: Door thickness up to 16 mm
Cup depth 11.3 mm
Clip on with various plate options



DESCRIPTION	APPLICATION	CODE	PACK SIZE
OMNI HINGE CLICK-ON SCREW IN	INSET/BLIND CORNER HINGE	C12T03	100
OMNI HINGE CLICK-ON DOWEL	INSET/BLIND CORNER HINGE	C12T03N	100

FEATURES: Door thickness up to 16 mm
Cup depth 11.3 mm
Clip on with various plate options



DESCRIPTION	APPLICATION	CODE	PACK SIZE
OMNI HINGE CLICK-ON SCREW IN	BI-FOLD/PIE-CUT FULL HOLE	C12T04	100
OMNI HINGE CLICK-ON DOWEL	BI-FOLD/PIE-CUT FULL HOLE	C12T04N	100

FEATURES: Door thickness up to 16 mm
Cup depth 11.3 mm
Clip on with various plate options

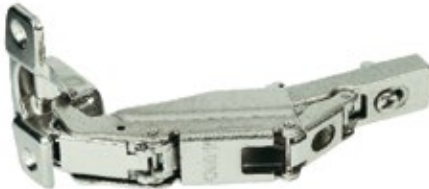

DESCRIPTION	APPLICATION	CODE	PACK SIZE
OMNI HINGE CLICK-ON SCREW IN	FULL OVERLAY 165°	C2016	100
OMNI HINGE CLICK-ON DOWEL	FULL OVERLAY 165°	C2016N	100

FEATURES: Door thickness up to 16 mm
Cup depth 11.3 mm
Clip on with various plate options



DESCRIPTION	APPLICATION	CODE	PACK SIZE
OMNI M/PLATE CLICK-ON	SCREW FIX	C02H04HOLE	500



DESCRIPTION	APPLICATION	CODE	PACK SIZE
OMNI M/PLATE CLICK-ON	10 MM MOUNTED EURO SCREW	C02H0D-10	500
OMNI M/PLATE CLICK-ON	13 MM MOUNTED EURO SCREW	C02H0D-13	500



DESCRIPTION	APPLICATION	CODE	PACK SIZE
OMNI HINGE AND PLATE SLIDE-ON SCREW IN	FULL OVERLAY	2811.007	200 PREPACK
OMNI HINGE SLIDE-ON SCREW IN	FULL OVERLAY	2809.400	200
OMNI HINGE SLIDE-ON DOWEL	FULL OVERLAY	2809.400N	200
OMNI HINGE AND PLATE SLIDE-ON SCREW IN	HALF OVERLAY	2811.015	200 PREPACK
OMNI HINGE SLIDE-ON SCREW IN	HALF OVERLAY	2809.405	200
OMNI HINGE SLIDE-ON DOWEL	HALF OVERLAY	2809.405N	200
OMNI M/PLATE SLIDE-ON	4 HOLE SCREW-IN	2809.626	200
OMNI M/PLATE SLIDE-ON	2 HOLE MOUNTED EURO SCREW	2809.526	200

FEATURES: Pre-packed



DESCRIPTION	APPLICATION	CODE	PACK SIZE
OMNI FACE FRAME HINGE + PLATE SCREW-IN	HALF OVERLAY	C1503+	250

FEATURES: Face Frame Application



CODE	DESCRIPTION	SIZE	PACK SIZE	FINISH
OUM301/400	OMNI UNDERMOUNT SINGLE EXTENSION 25 KG	400 MM	10	ZINC
OUM301/450	OMNI UNDERMOUNT SINGLE EXTENSION 25 KG	450 MM	10	ZINC
OUM301/500	OMNI UNDERMOUNT SINGLE EXTENSION 25 KG	500 MM	10	ZINC



CODE	DESCRIPTION	SIZE	PACK SIZE	FINISH
550-704-086X270W	OMNI SUPER STEEL DRAWER SLIDE	86 x 270	10	WHITE
550-704-086X350W	OMNI SUPER STEEL DRAWER SLIDE	86 x 350	10	WHITE
550-704-086X400W	OMNI SUPER STEEL DRAWER SLIDE	86 x 400	10	WHITE
550-704-086X450W	OMNI SUPER STEEL DRAWER SLIDE	86 x 450	10	WHITE
550-704-086X500W	OMNI SUPER STEEL DRAWER SLIDE	86 x 500	10	WHITE
550-704-086X550W	OMNI SUPER STEEL DRAWER SLIDE	86 x 550	10	WHITE
550-704-150X450W	OMNI SUPER STEEL DRAWER SLIDE	150 x 450	10	WHITE
550-704-150X500W	OMNI SUPER STEEL DRAWER SLIDE	150 x 500	10	WHITE
5501	MARKING JIG FOR DRAWER FRONTS		1	BLACK

CODE	DESCRIPTION	PACK SIZE	FINISH
4401.125	SOFT-CLOSE ADAPTER	EACH	GREY
4401.159	SOFT-CLOSE PIN FOR STEEL SIDE DRAWER	EACH	WHITE
4401.143	SOFT-CLOSE PIN FOR WOODEN DRAWER	EACH	GREY



CODE	DESCRIPTION	SIZE	PACK SIZE	FINISH
MBBF/250	OMNI BALL BEARING FULL EXTENSION 45 KG	250 MM	10	ZINC
MBBF/300	OMNI BALL BEARING FULL EXTENSION 45 KG	300 MM	10	ZINC
MBBF/350	OMNI BALL BEARING FULL EXTENSION 45 KG	350 MM	10	ZINC
MBBF/400	OMNI BALL BEARING FULL EXTENSION 45 KG	400 MM	10	ZINC
MBBF/450	OMNI BALL BEARING FULL EXTENSION 45 KG	450 MM	10	ZINC
MBBF/500	OMNI BALL BEARING FULL EXTENSION 45 KG	500 MM	10	ZINC
MBBF/550	OMNI BALL BEARING FULL EXTENSION 45 KG	550 MM	10	ZINC
MBBF/600	OMNI BALL BEARING FULL EXTENSION 45 KG	600 MM	10	ZINC



CODE	DESCRIPTION	SIZE	PACK SIZE	FINISH
MBBF/350SC	OMNI BALL BEARING FULL EXTENSION SOFT-CLOSE 45 KG	350 MM	10	ZINC
MBBF/400SC	OMNI BALL BEARING FULL EXTENSION SOFT-CLOSE 45 KG	400 MM	10	ZINC
MBBF/450SC	OMNI BALL BEARING FULL EXTENSION SOFT-CLOSE 45 KG	450 MM	10	ZINC
MBBF/500SC	OMNI BALL BEARING FULL EXTENSION SOFT-CLOSE 45 KG	500 MM	10	ZINC
MBBF/550SC	OMNI BALL BEARING FULL EXTENSION SOFT-CLOSE 45 KG	550 MM	10	ZINC



DESCRIPTION	CODE	SIZE	FINISH
		W x D	
NOVA PRO 450 MM CUTLERY INSERT	CNP450/500WH	360 X 480	WHITE
VIONARO 450 MM CUTLERY INSERT	CVI450/500WH	375 X 473	WHITE
DWD XP 450 MM CUTLERY INSERT	CXP450/500WH	356 X 473	WHITE
INTEGRA 450 MM CUTLERY INSERT	CIN450/500WH	387 X 480	WHITE
NOVA PRO 450 MM CUTLERY INSERT	CNP450/500SIL	360 X 480	SILVER
VIONARO 450 MM CUTLERY INSERT	CVI450/500SIL	375 X 473	SILVER
DWD XP 450 MM CUTLERY INSERT	CXP450/500SIL	356 X 473	SILVER
NOVA PRO 450 MM CUTLERY INSERT	CNP450/500GRP	360 X 480	GRAPHITE
VIONARO 450 MM CUTLERY INSERT	CVI450/500GRP	375 X 473	GRAPHITE



DESCRIPTION	CODE	SIZE	FINISH
		W x D	
NOVA PRO 600 MM CUTLERY INSERT	CNP600/500WH	510 X 480	WHITE
VIONARO 600 MM CUTLERY INSERT	CVI600/500WH	525 X 473	WHITE
DWD XP 600 MM CUTLERY INSERT	CXP600/500WH	506 X 473	WHITE
INTEGRA 600 MM CUTLERY INSERT	CIN600/500WH	537 X 480	WHITE
NOVA PRO 600 MM CUTLERY INSERT	CNP600/500SIL	510 X 480	SILVER
VIONARO 600 MM CUTLERY INSERT	CVI600/500SIL	525 X 473	SILVER
DWD XP 600 MM CUTLERY INSERT	CXP600/500SIL	506 X 473	SILVER
NOVA PRO 600 MM CUTLERY INSERT	CNP600/500GRP	510 X 480	GRAPHITE
VIONARO 600 MM CUTLERY INSERT	CVI600/500GRP	525 X 473	GRAPHITE



DESCRIPTION	CODE	SIZE	FINISH
		W x D	
NOVA PRO 900 MM CUTLERY INSERT	CNP900/500WH	810 X 480	WHITE
VIONARO 900 MM CUTLERY INSERT	CVI900/500WH	825 X 473	WHITE
DWD XP 900 MM CUTLERY INSERT	CXP900/500WH	806 X 473	WHITE
NOVA PRO 900 MM CUTLERY INSERT	CNP900/500SIL	810 X 480	SILVER
VIONARO 900 MM CUTLERY INSERT	CVI900/500SIL	825 X 473	SILVER
DWD XP 900 MM CUTLERY INSERT	CXP900/500SIL	806 X 473	SILVER
NOVA PRO 900 MM CUTLERY INSERT	CNP900/500GRP	810 X 480	GRAPHITE
VIONARO 900 MM CUTLERY INSERT	CVI900/500GRP	825 X 473	GRAPHITE



DESCRIPTION	CODE	SIZE	FINISH
		W x D	
CLASSICO KNIFE INSERT	CKNIFE/WH	165 X 440	WHITE
CLASSICO KNIFE INSERT	CKNIFE/GRP	165 X 440	GRAPHITE
CLASSICO KNIFE INSERT	CKNIFE/SIL	165 X 440	SILVER



DESCRIPTION	CODE	SIZE	FINISH
		W x D	
CLASSICO SPICE INSERT	CSPICE/WH	165 X 440	WHITE
CLASSICO SPICE INSERT	CSPICE/GRP	165 X 440	GRAPHITE
CLASSICO SPICE INSERT	CSPICE/SIL	165 X 440	SILVER



DESCRIPTION	CODE	SIZE	FINISH
		W x D	
TAVINEA SORTO B276 - NOVAPRO	F007130058201	276 X 500	STONE
TAVINEA SORTO B276 - NOVAPRO	F007130059201	276 X 500	SILVER
TAVINEA SORTO B276 - VIONARO AND DWD XP	F007130137201	276 X 500	GRAPHITE
TAVINEA SORTO B276 - NOVAPRO	F007130062201	276 X 550	STONE



DESCRIPTION	CODE	SIZE	FINISH
		W x D	
TAVINEA SORTO B186 - NOVAPRO	F007130086201	186 X 500	STONE
TAVINEA SORTO B186 - NOVAPRO	F007130087201	186 X 500	SILVER
TAVINEA SORTO B186 - VIONARO AND DWD XP	F007130158201	186 X 500	GRAPHITE
TAVINEA SORTO B186 - NOVAPRO	F007130090201	186 X 550	STONE



DESCRIPTION	CODE	DEPTH	FINISH
TAVINEA SORTO DIVIDER RAIL - NOVAPRO	F007130114207	500	STONE
TAVINEA SORTO DIVIDER RAIL - NOVAPRO	F007130115207	500	SILVER
TAVINEA SORTO DIVIDER RAIL - VIONARO AND DWD XP	F007130179207	500	GRAPHITE
TAVINEA SORTO DIVIDER RAIL - NOVAPRO	F007130118207	550	STONE



DESCRIPTION	CODE	SIZE	FINISH
		W x D	
TAVINEA SORTO KNIFE BLOCK - NOVAPRO	F007101995201	185 X 500	DARK ASH
TAVINEA SORTO KNIFE BLOCK - VIONARO AND DWD XP	F007102424201	185 X 500	DARK ASH



DESCRIPTION	CODE	SIZE	FINISH
		W x D	
TAVINEA SORTO KNIFE BLOCK - NOVAPRO	F007101990201	185 X 500	LIGHT ASH
TAVINEA SORTO KNIFE BLOCK - VIONARO AND DWD XP	F007102418201	185 X 500	LIGHT ASH



DESCRIPTION	CODE	SIZE	FINISH
		W x D	
TAVINEA SORTO SPICE RACK - NOVAPRO	F007101997201	185 X 500	DARK ASH
TAVINEA SORTO SPICE RACK - VIONARO AND DWD XP	F007102426201	185 X 500	DARK ASH



DESCRIPTION	CODE	SIZE	FINISH
		W x D	
TAVINEA SORTO SPICE RACK - NOVAPRO	F007101992201	185 X 500	LIGHT ASH
TAVINEA SORTO SPICE RACK - VIONARO AND XP	F007102420201	185 X 500	LIGHT ASH



DESCRIPTION	CODE	SIZE	FINISH
		W x D	
TAVINEA SORTO FOIL HOLDER - NOVAPRO	F007101999201	185 X 500	DARK ASH
TAVINEA SORTO FOIL HOLDER - VIONARO AND DWD XP	F007102428201	185 X 500	DARK ASH



DESCRIPTION	CODE	SIZE	FINISH
		W x D	
TAVINEA SORTO FOIL HOLDER - NOVAPRO	F007101994201	185 X 500	LIGHT ASH
TAVINEA SORTO FOIL HOLDER - VIONARO AND DWD XP	F007102422201	185 X 500	LIGHT ASH



DESCRIPTION	CODE	SIZE	FINISH
		W x D	
TAVINEA SORTO SQUARE ELEMENT	F007102423201	185 X 208	LIGHT ASH
TAVINEA SORTO SQUARE ELEMENT	F007102429201	185 X 208	DARK ASH



TAVINEA SORTO ORGANISING SYSTEM

www.grass.co.za

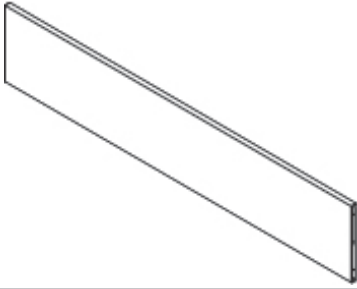

DESCRIPTION	CODE	COLOUR	PACK SIZE
TAVINEA OPTIMA DIVIDER PROFILE 1200 MM	F007130242507	GRAHITE	EACH
TAVINEA OPTIMA DIVIDER PROFILE 1200 MM	F007130243507	WHITE	EACH
TAVINEA OPTIMA DIVIDER PROFILE 1200 MM	F007130241507	SILVER	EACH

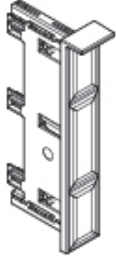

DESCRIPTION	CODE	COLOUR	PACK SIZE
TAVINEA OPTIMA PROFILE CLIP	F007130228511	GRAHITE	SET
TAVINEA OPTIMA PROFILE CLIP	F007130229511	WHITE	SET
TAVINEA OPTIMA PROFILE CLIP	F007130230511	SILVER	SET

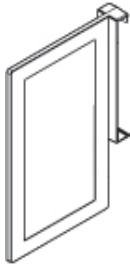

DESCRIPTION	CODE	COLOUR	PACK SIZE
TAVINEA OPTIMA SMART BOARD	F007130245211	GRAHITE	EACH
TAVINEA OPTIMA SMART BOARD	F007130246211	WHITE	EACH
TAVINEA OPTIMA SMART BOARD	F007130247211	SILVER	EACH

FEATURES: Dividing system for pot drawers
Tool-free installation
Tool-free adjustment
Can be retrofitted

Colour coordinated with drawer sides
Can work with Vionaro, Novapro Scala and wooden drawers
Organises the storage space for clear and tidy arrangement
*Only applicable for 185 mm height sides





DESCRIPTION	CODE	SIZE	FINISH
RUBBER CANVAS MAT	CMAT/SIL	25 M X 480 MM	SILVER
RUBBER CANVAS MAT	CMAT/GRP	25 M X 480 MM	GRAPHITE
RUBBER CANVAS MAT	CMAT/GRP 550	25 M X 530 MM	GRAPHITE



DESCRIPTION	CODE	SIZE	FINISH
RUBBER MAT SOLID	CMAT/WH	25 M X 480 MM	WHITE
RUBBER MAT SOLID	CMAT/WH 550	25 M X 530 MM	WHITE

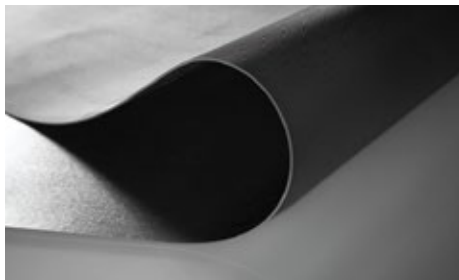

DESCRIPTION	CODE	SIZE	FINISH
RUBBER MAT GLOBE	CMAT/BLK	25 M X 480 MM	BLACK
RUBBER MAT GLOBE	CMAT/BLK 550	25 M X 530 MM	BLACK

FEATURES: Our non-slip mats are highly practical and offer additional benefits. The anti-slip surface prevents objects from sliding about when drawers are opened and closed. It can also be easily removed for cleaning. Our mats can also be cut to fit most drawer sizes. *Sold per/m





DESCRIPTION	CODE	SIZE	FINISH
GOLA HANDLE SLIM C ALU	SNA211CS	49 MM X 3 M	ALU
GOLA HANDLE SLIM L ALU	SNA211LS	40 MM X 3 M	ALU
GOLA HANDLE SLIM C BLACK	SNA211CB	49 MM X 3 M	BLACK
GOLA HANDLE SLIM L BLACK	SNA211LB	40 MM X 3 M	BLACK
GOLA HANDLE SLIM C WHITE	SNA211CW	49 MM X 3 M	WHITE
GOLA HANDLE SLIM L WHITE	WSNA211LB	40 MM X 3 M	WHITE
FIXING BRACKET SLIM	SNA/F	-	STEEL

FEATURES: Allows for more height spacing inside the drawers
 Square cut out
 Makes vertical applications possible
 End caps available for both options
 More accurate cutting for mitre joints
 Straight edge profile gives more elegant look

STANDARD:

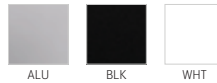

Custom: Other colours available on request, minimum order of 10 lengths.



DESCRIPTION	CODE	SIZE	FINISH
GOLA HANDLE C ALU	NA211CS	65 MM X 3 M	ALU
GOLA HANDLE L ALU	NA211LS	50 MM X 3 M	ALU
GOLA HANDLE C BLACK	NA211CSB	65 MM X 3 M	BLACK
GOLA HANDLE L BLACK	NA211LSB	50 MM X 3 M	BLACK
GOLA HANDLE C WHITE	NA211CSW	65 MM X 3 M	WHITE
GOLA HANDLE L WHITE	NA211LSW	50 MM X 3 M	WHITE
FIXING BRACKET	NA/F	-	STEEL

FEATURES: Round cut out
 End caps available for all colours

STANDARD:



Custom: Other colours available on request, minimum order of 10 lengths.



DESCRIPTION	CODE	SIZE	FINISH
STRIP HANDLE 32 MM ALU	VD5_ALU	3 M	ALU
STRIP HANDLE 32 MM BRUSHED STEEL FINISH	VD5_SS	3 M	S/STEEL
STRIP HANDLE 32 MM WHITE	VD5_WHT	3 M	WHITE
STRIP HANDLE 32 MM BLACK	VD5_BLK	3 M	BLACK
STRIP HANDLE 32 MM GRAPHITE	VD5_GRP	3 M	GRAPHITE

FEATURES: Suitable for cabinet doors and drawer fronts.
 Vertical mounting for all doors
 Horizontal mounting for drawers
 Can be cut to size
 Can be powder coated
 Black & Alu available in pre-cut sizes of 100 mm, 200 mm and 300 mm

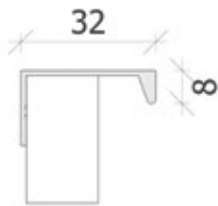

STANDARD:

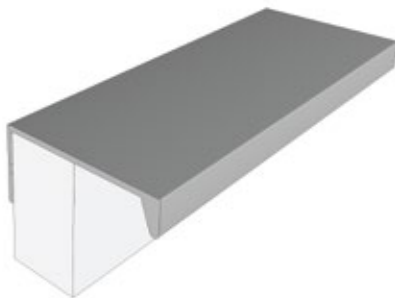

DESCRIPTION	CODE	SIZE	FINISH
STRIP HANDLE 38 MM ALU	VD6_ALU	3 M	ALU
STRIP HANDLE 38 MM WHITE	VD6_WHT	3 M	WHITE
STRIP HANDLE 38 MM BLACK	VD6_BLK	3 M	BLACK
STRIP HANDLE 38 MM GRAPHITE	VD6_GRP	3 M	GRAPHITE

FEATURES: Suitable for cabinet doors and drawer fronts.
 Vertical mounting for all doors
 Horizontal mounting for drawers
 Can be cut to size
 Can be powder coated
 Black & Alu available in pre-cut sizes of 100 mm, 200 mm and 300 mm

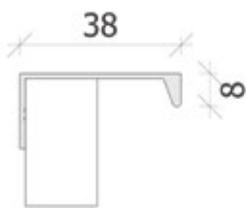

STANDARD:





DESCRIPTION	CODE	SIZE	FINISH
FINGER GRIP HANDLE SHORT ALUMINIUM	VD9_ALU	3 M	ALU
FINGER GRIP HANDLE SHORT BLACK	VD9_BLK	3 M	BLACK

FEATURES: Cabinet Doors and Drawer Fronts
 Top or bottom mounted to doors and drawer fronts
 Can be used in conjunction with VD10

STANDARD:

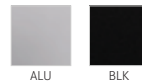

ON REQUEST:

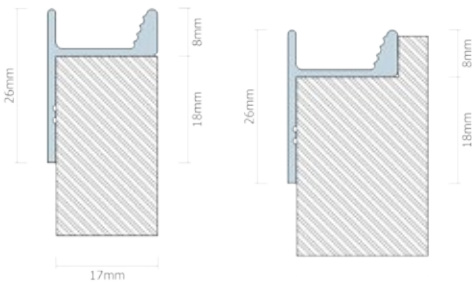

DESCRIPTION	CODE	SIZE	FINISH
FINGER GRIP HANDLE LONG ALUMINIUM	VD10_ALU	3 M	ALU
FINGER GRIP HANDLE LONG BLACK	VD10_BLK	3 M	BLACK
FINGER GRIP HANDLE LONG WITH LIP	VD10.LIP_ALU	3 M	ALU
FINGER GRIP HANDLE LONG WITH LIP	VD10.LIP_BLK	3 M	BLACK

FEATURES: Cabinet Doors and Drawer Fronts
 Top or bottom mounted to doors and drawer fronts
 Can be used in conjunction with VD9

STANDARD:



ON REQUEST:

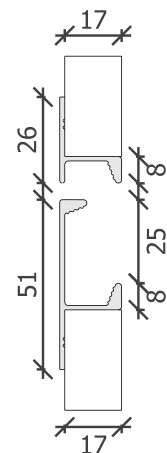
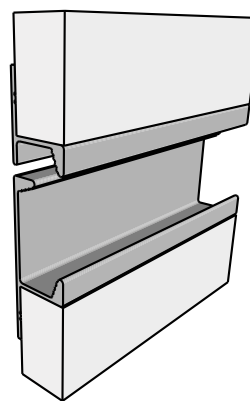
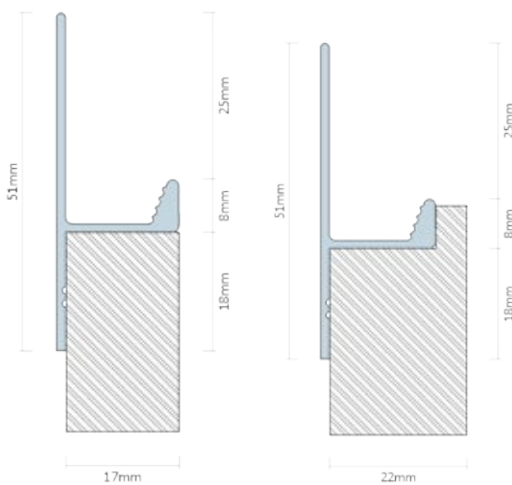



DISPLAY WINE

www.displaywine.com



DESCRIPTION	CODE	SIZE	FINISH
DISPLAY PIN - SINGLE BOTTLE_SILVER	DP_SINGLE_SILV	1 BOTTLE SET	SILVER
DISPLAY PIN - DOUBLE BOTTLE_SILVER	DP_DOUBLE_SILV	2 BOTTLE SET	SILVER
DISPLAY PIN - TRIPLE BOTTLE_SILVER	DP_TRIPLE_SILV	3 BOTTLE SET	SILVER



DESCRIPTION	CODE	SIZE	FINISH
DISPLAY PIN - SINGLE BOTTLE_BLACK	DP_SINGLE_BLK	1 BOTTLE SET	BLACK
DISPLAY PIN - DOUBLE BOTTLE_BLACK	DP_DOUBLE_BLK	2 BOTTLE SET	BLACK
DISPLAY PIN - TRIPLE BOTTLE_BLACK	DP_TRIPLE_BLK	3 BOTTLE SET	BLACK



DESCRIPTION	CODE	QTY	FINISH
VINOWALL PINS WITH 50 MM SCREW - 150MM_ALU	V_PINS10_ALU	10	ALU
VINOWALL PINS WITH 50 MM SCREW - 150MM_ALU	V_PINS100_ALU	100	ALU



DESCRIPTION	CODE	QTY	FINISH
VINOWALL PINS WITH 50 MM SCREW - 150MM_BLACK	V_PINS10_BLK	10	BLACK
VINOWALL PINS WITH 50 MM SCREW - 150MM_BLACK	V_PINS100_BLK	100	BLACK





DESCRIPTION	CODE	SIZE	FINISH
WINE CRADLE WITH SCREWS - 150MM_BLACK	WCRADLE.10_BLK	10	BLACK
WINE CRADLE WITH SCREWS - 150MM_BLACK	WCRADLE.100_BLK	100	BLACK



DESCRIPTION	CODE	SIZE	FINISH
WINE CRADLE MAX WITH SCREWS - DOUBLE BOTTLE - 150MM_BLACK	WCRADLE_MAX.10_BLK	10	BLACK



DESCRIPTION	CODE	SIZE	FINISH
BLACK SPINE WITH BLACK CRADLES_700 MM	SPINE_700.BBLK	7 BOTTLES	BLACK
BLACK SPINE WITH BLACK CRADLES_1400 MM	SPINE_1400.BBLK	14 BOTTLES	BLACK
BLACK SPINE WITH BLACK CRADLES_2100 MM	SPINE_2100.BBLK	21 BOTTLES	BLACK



DESCRIPTION	CODE	SIZE	FINISH
BLACK SPINE WITH BLACK CRADLE MAX_700 MM	SPINE.MAX_700.BBLK	14 BOTTLES	BLACK
BLACK SPINE WITH BLACK CRADLE MAX_1400 MM	SPINE.MAX_1400.BBLK	28 BOTTLES	BLACK
BLACK SPINE WITH BLACK CRADLE MAX_2100 MM	SPINE.MAX_2100.BBLK	42 BOTTLES	BLACK



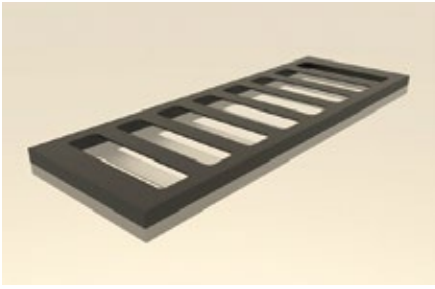

DESCRIPTION	CODE	QTY	FINISH
WINE SHELF BLACK FRAME, BLACK PANEL - CORK FACING	SHELF_566X297_B.BLK	5 BOTTLES	BLACK
WINE SHELF BLACK FRAME, BLACK PANEL - CORK FACING	SHELF_866X297_B.BLK	8 BOTTLES	BLACK
WINE SHELF BLACK FRAME, BLACK PANEL - CORK FACING	SHELF_1166X297_B.BLK	11 BOTTLES	BLACK





DESCRIPTION	CODE	+	ADD	+	ADD	+	ADD	SIZE	FINISH
	300/1800 FRAME	FULL EXTENSION SLIDE	SOFT-CLOSE	5 BASKETS					
SOLID BASE PULL-OUT LARDER	295A		295K		2950		296+	300 MM	CHROME
SOLID BASE PULL-OUT LARDER	295 GRAPHITE		295K GRAPHITE		2950		296+GREY	300 MM	GRAPHITE

FEATURES: Soft-close (Optional)
 Weight capacity - 80 kg
 Solid base baskets
 Available in Chrome and Graphite



DESCRIPTION	CODE	+	ADD	SIZE	FINISH
			NOVA PRO RUNNER		
SOLID BASE PULL-OUT	119+GRASS 450		F101108276211	450 MM	CHROME
SOLID BASE PULL-OUT	119+GRASS 600		F101108276211	600 MM	CHROME
SOLID BASE PULL-OUT	119+GRASS 900		F101108276211	900 MM	CHROME

DESCRIPTION	CODE	+	ADD	SIZE	FINISH
			NOVA PRO RUNNER		
SOLID BASE PULL-OUT	119+GRASS 450 GR		F101108276211	450 MM	GRAPHITE
SOLID BASE PULL-OUT	119+GRASS 600 GR		F101108276211	600 MM	GRAPHITE
SOLID BASE PULL-OUT	119+GRASS 900 GR		F101108276211	900 MM	GRAPHITE

FEATURES: Soft-close
 Weight capacity - 40 kg
 Full extension drawer slide
 Fully synchronised
 Solid base
 Available in Chrome and Graphite



DESCRIPTION	CODE	SIZE	FINISH
SIGE 3/4 CAROUSEL FLAT WIRE	363+	800 MM	CHROME
SIGE 3/4 CAROUSEL FLAT WIRE	363+ GRAPHITE	800 MM	GRAPHITE

DESCRIPTION	CODE	SIZE	FINISH
SIGE 3/4 CAROUSEL ROUND WIRE	363I	700 MM	CHROME

FEATURES:	Retrofit Shelf mounted	Assembly on cabinet base Height adjustment + 3.5 m	2 x Shelves per set
------------------	---------------------------	---	---------------------



DESCRIPTION	CODE	SIZE	MIN DOOR SIZE	FINISH
SIGE BLIND CORNER LEFT	371+LH SC	900 MM	450 MM	CHROME
SIGE BLIND CORNER RIGHT	371+RH SC	900 MM	450 MM	CHROME
SIGE BLIND CORNER LEFT	371+LH GRAPHITE	900 MM	450 MM	GRAPHITE
SIGE BLIND CORNER RIGHT	371+RH GRAPHITE	900 MM	450 MM	GRAPHITE

- FEATURES:**
- Retrofit
 - Shelf mounted
 - Weight capacity 25 kg per shelf
 - More stability
 - Easy to install
 - 2 x Shelves per set
 - Soft-close





DESCRIPTION	CODE	+	ADD	SIZE	FINISH
			NOVA PRO RUNNER		
SOLID BASE PULL-OUT	002+GRASS		F101108277L X 2	150 MM	CHROME
SOLID BASE PULL-OUT	002+GRAPHITE		F101108277L X 2	150 MM	GRAPHITE

DESCRIPTION	CODE		SIZE	FINISH
BOTTLE RACK DIVIDER KIT	065+		150 MM	CLEAR

- FEATURES:**
- Soft-close
 - Weight capacity - 40 kg
 - Full extension drawer slide
 - Fully synchronised
 - Solid base
 - Available in Chrome and Graphite
 - Access from both sides
 - Left hand runner mounting



DESCRIPTION	CODE	ADD	SIZE	FINISH
		NOVA PRO RUNNER		
SOLID BASE PULL-OUT	004+GRASS	F101108276211	300 MM	CHROME
SOLID BASE PULL-OUT	004+GRAPHITE	F101108276211	300 MM	GRAPHITE

DESCRIPTION	CODE		SIZE	FINISH
BOTTLE RACK DIVIDER KIT	066+		300 MM	CHROME
BOTTLE RACK DIVIDER KIT	066+GREY		300 MM	GRAPHITE

FEATURES:

- Soft-close or Push to open
- Weight capacity - 40 kg
- Full extension drawer slide
- Fully synchronised
- Solid base
- Available in Chrome and Graphite



DESCRIPTION	CODE	+	ADD	SIZE	CAPACITY
			NOVA PRO RUNNER		
PULL-OUT RECYCLING BIN	564		F101108276211	300 MM	35 LITRES
PULL-OUT RECYCLING BIN	560		F101108276211	400 MM	35 LITRES



FEATURES: Soft-close or Push to open
 Weight capacity - 40 kg
 Full extension drawer slide
 Fully synchronised
 Concealed runner
 Fixed shelf
 Height 560
 Graphite Colour



DESCRIPTION	CODE	+	ADD	SIZE	CAPACITY
			NOVA PRO RUNNER		
PULL-OUT RECYCLING BIN	561		F101108276211	450 MM	70 LITRES
PULL-OUT RECYCLING BIN	562		F101108276211	500 MM	70 LITRES



FEATURES: Soft-close or Push to open
 Weight capacity - 40 kg
 Full extension drawer slide
 Fully synchronised
 Concealed runner
 Fixed shelf
 Height 560
 Graphite Colour



DESCRIPTION	CODE	+	ADD	SIZE	CAPACITY
			NOVA PRO RUNNER		
PULL-OUT RECYCLING BIN	563		F101108276211	600 MM	85 LITRES



FEATURES: Soft-close or Push to open
 Weight capacity - 40 kg
 Full extension drawer slide
 Fully synchronised
 Concealed runner
 Fixed shelf
 Height 560
 Graphite Colour



DESCRIPTION	CODE	+	ADD	SIZE	CAPACITY
			NOVA PRO RUNNER		
PULL-OUT WASTE BIN UNDER SINK	575		F101108273211	600 MM	36 LITRES



FEATURES: Soft-close
 Weight capacity - 40 kg
 Full extension drawer slide - 450 mm
 Fully synchronised
 Concealed runner
 Fixed shelf
 Height - 360 mm
 Bin depth - 450 mm
 Grey colour



DESCRIPTION	CODE	SIZE	CAPACITY
AUTO OPEN BIN BASE MOUNT	520	450 MM	32 LITRES



FEATURES: Opens with the door
 Base mounted
 Double bin
 Fits under sink
 Height - 380 mm
 Bin Depth - 460 mm
 Grey and white colour



DESCRIPTION	CODE	SIZE	CAPACITY
PULL-OUT WASTE BIN BASE MOUNT	540	300 MM	21 LITRES



FEATURES: Base mounted
 Fits under sink
 Height - 400 mm
 Bin Depth - 460 mm
 Grey and white colour



DESCRIPTION	CODE	COLOUR	CAPACITY
SIGE TOMMI WASTE BIN	501	GREY	24 LITRES



FEATURES: Door mounted
Easy installation
Includes lid and frame
Height: 440 mm
Bin Depth: 230 mm
Width: 290 mm



DESCRIPTION	CODE	COLOUR	CAPACITY
HANGING COMPOST BIN	557	GREY	5 LITRES



FEATURES: Hangs on the 35 liter bin
Used for compost degradable refuse
Light and convenient to empty daily
Height: 180 mm
Bin Depth: 185 mm
Width: 245 mm



DESCRIPTION	CODE	COLOUR	CAPACITY
SIGE WASTE BIN	56000000	GRAPHITE	35 LITRES

FEATURES: Allow for custom built bin drawers
Includes lid to lock out odours
Height: 540 mm
Bin Depth: 240 mm
Width: 375 mm



DESCRIPTION	CODE	SIZE	CAPACITY
COUNTER TOP BIN	IRCO05PP	300 MM	8 LITRE

FEATURES: Bin intergrated into counter top
Removeable
Easy access



DESCRIPTION	CODE	SIZE			FINISH
		W	D	H	
WASTE BIN 45 L + LID	H6245	380	330	660	GREY
BIN BRACKET FOR 45L BIN	B/BIN BRACKET				WHITE
FLAP STAY	356.050.00.0070				CHROME



DESCRIPTION	CODE	SIZE	FINISH
KPUSH TECH WITH BUFFER STRONG	57008080AB	70 MM	WHITE
MOUNTING PLATE WITH HOUSING	57010040	80 MM	WHITE
KPUSH TECH WITH BUFFER STRONG	57008080EE	70 MM	GRAPHITE
MOUNTING PLATE WITH HOUSING	57010040G	80 MM	GRAPHITE



DESCRIPTION	CODE	SIZE	FINISH
KPUSH TECH WITH BUFFER NORMAL	57008040AB	70 MM	WHITE
MOUNTING PLATE WITH HOUSING	57010040	80 MM	WHITE
KPUSH TECH WITH BUFFER NORMAL	57008040EE	70 MM	GRAPHITE
MOUNTING PLATE WITH HOUSING	57010040G	80 MM	GRAPHITE



DESCRIPTION	CODE	SIZE	FINISH
KPUSH TECH WITH MAGNET + SCREW	57008020	70 MM	WHITE
MOUNTING PLATE WITH HOUSING	57010040	80 MM	WHITE
KPUSH TECH WITH MAGNET + SCREW	57008020G	70 MM	GRAPHITE
MOUNTING PLATE WITH HOUSING	57010040G	80 MM	GRAPHITE





DESCRIPTION	CODE	SIZE	FINISH
RECESSING DOOR SYS HEAVY DUTY+HINGES+BAR	KV8092/500	500 MM	BLACK
RECESSING DOOR SYS HEAVY DUTY+HINGES+BAR	KV8092/600	600 MM	BLACK

FEATURES: Height up to 2000 mm
 Door thickness up to 22 mm
 Gear system
 No Sagging of doors
 Up to a maximum weight capacity of 35 Kg per door
 Inset or overlay of 6 mm application only



DESCRIPTION	CODE	SIZE	FINISH
WARDROBE LIFT - 20KG	W/SUPER LIFT	750 - 1150 MM	GREY



DESCRIPTION	CODE	SIZE	FINISH
SHOE P/OUT 600CR & RUNNER	B/SHOE P/O 600R	568 X 500 X 160	CHROME
SHOE P/OUT 900CR & RUNNER	B/SHOE P/O 900R	868 X 500 X 160	CHROME



DESCRIPTION	CODE	SIZE	FINISH
COAT RAIL OVAL	B/RAIL	15 X 30 X 3000	CHROME
ROD HOLDER	B/ROD HOLDER	15 X 30	CHROME
CENTRE SUPPORT	B/HOLDER SUPPORT	15 X 30	CHROME



DESCRIPTION	CODE	SIZE	FINISH
OVAL RAIL	B/RAIL ALU	19 X 34 X 3000	ALU
HANG RAIL BRACKET	T128W	20 X 35	WHITE





DESCRIPTION	CODE	SIZE	FINISH
CHROME WIRE BASKET	V/B400C	400 MM CARCASS	CHROME
CHROME WIRE BASKET	V/B450C	450 MM CARCASS	CHROME
CHROME WIRE BASKET	V/B500C	500 MM CARCASS	CHROME
CHROME WIRE BASKET	V/B600C	600 MM CARCASS	CHROME

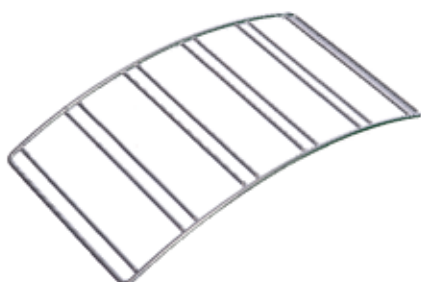

DESCRIPTION	CODE	SIZE	FINISH
CURVED WINE BOTTLE RACK	WR240D	400 MM	CHROME
CURVED WINE BOTTLE RACK	WR250D	500 MM	CHROME
CURVED WINE BOTTLE RACK	WR260D	600 MM	CHROME



DESCRIPTION	CODE	SIZE	FINISH
VOLPATO LEG	C/LEG 100P	100 MM	BLACK
VOLPATO LEG	C/LEG 150P	150 MM	BLACK
SKIRTING CLIP WOOD	C/CLIP/P	-	BLACK
SKIRTING CLIP ALU	C/CLIP/K	-	BLACK



DESCRIPTION	CODE	SIZE	FINISH
BRUSHED ALU KICK PLATE 100 MM X 4 M	AKP 100 BRU	100 MM	BRUSHED ALU
BRUSHED ALU KICK PLATE 150 MM X 4 M	AKP 150 BRU	150 MM	BRUSHED ALU
BRUSHED ALU KICK PLATE 100 MM FLEXIBLE CORNER	AKP 100 BRU FLEX CNR	100 MM	BRUSHED ALU
BRUSHED ALU KICK PLATE 150 MM FLEXIBLE CORNER	AKP 150 BRU FLEX CNR	150 MM	BRUSHED ALU
BRUSHED ALU KICK PLATE 100 MM 90 DEG FIXED CORNER	AKP 100 BRU 90 DEG CNR	100 MM	BRUSHED ALU
BRUSHED ALU KICK PLATE 150 MM 90 DEG FIXED CORNER	AKP 150 BRU 90 DEG CNR	150 MM	BRUSHED ALU



DESCRIPTION	CODE	SIZE	FINISH
STICK ON DOOR BUMPER	F146073835253	7 MM	CLEAR
STICK ON DOOR BUMPER	F146073836256	10 MM	CLEAR
DOOR BUMPER DRILL IN	630.000.03.0850	5 MM	CLEAR

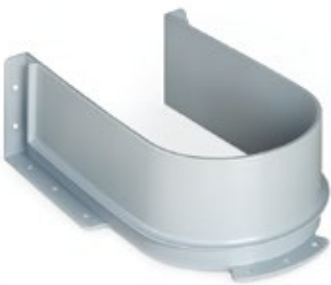

DESCRIPTION	CODE	SIZE	FINISH
SHELF CUT-OUT COVER FOR TRAP - GREY	TRAP/SHELF COVER GREY	240 x 120 x 83	GREY PLASTIC
SHELF CUT-OUT COVER FOR TRAP - WHITE	TRAP/SHELF COVER WHITE	240 x 120 x 83	WHITE PLASTIC



DESCRIPTION	CODE	SIZE	FINISH
GAS SPRING 80 N - WOOD/ALU	MZ3212	300 MM	GREY
GAS SPRING 100 N - WOOD/ALU	MZ3213	300 MM	GREY

	DESCRIPTION	CODE		DESCRIPTION	CODE
	SHELF SUPPORT CLEAR SHELF SUPPORT WHITE	517.006.00.0051 517.006.61.0051		SHELF SUPPORT GLASS	10208030YA
	SHELF SUPPORT NICKEL	F069073459253		SHELF SUPPORT NICKEL	10208020YA
	SHELF SUPPORT GLASS	517.206.65.0015		SHELF SUPPORT PIN	517.006.01.0015



DESCRIPTION	CODE	SIZE	FINISH
CAMFIX METAL	T3201	20 Ø X 13	NICKLE
CAMFIX PLASTIC	T3201B	20 Ø X 13	BROWN
CAMFIX PLASTIC	T3201W	20 Ø X 13	WHITE



DESCRIPTION	CODE	SIZE	FINISH
WEDGEFIX	T3241	20 Ø X 12	WHITE
WEDGEFIX	T3241B	20 Ø X 12	BROWN



DESCRIPTION	CODE	SIZE	FINISH
DOWEL 5 MM EURO	T3400	5 Ø X 11	ZINC
DOWEL 5 MM EURO SHORT	T3410	5 Ø X 7.5	ZINC



DESCRIPTION	CODE	SIZE	FINISH
DOWEL M4	T3470.009	M4 X 7.5	ZINC



DESCRIPTION	CODE	SIZE	FINISH
SLEEVE	T3051	5 Ø X M4 X 15	RAW



DESCRIPTION	CODE	SIZE	FINISH
CAM FITTING 15 MM	T3150	15 Ø X 12	ZINC



DESCRIPTION	CODE	SIZE	FINISH
DOWEL STEEL 5 MM - EURO THREAD	T3402	5 Ø X 34	RAW



DESCRIPTION	CODE	SIZE	FINISH
DOWEL STEEL M6	T3462	M6 X 34	RAW
DOWEL STEEL M4	T3470	M4 X 34	RAW



DESCRIPTION	CODE	SIZE	FINISH
QUICKFIT BOLT 8 X 34 MM EXPANDING DOWEL	T3491	8 Ø X 34	ZINC



DESCRIPTION	CODE	SIZE	FINISH
INSERT PLASTIC 10 MM X M6	T3800	10 Ø X 13 X M6	WHITE
INSERT PLASTIC 8 MM X M6	T3820	8 Ø X 13 X M6	WHITE



DESCRIPTION	CODE	SIZE	FINISH
EURO SCREW COUNTERSUNK	707.360.61.1015	6 X 10	NICKEL
EURO SCREW COUNTERSUNK	707.360.61.3015	6 X 13	NICKEL
EURO SCREW PAN HEAD	707.362.61.3015	6 X 13	NICKEL
EURO SCREW COUNTERSUNK FOR GRASS PRODUCTS	F145083544599	6 X 11.5	NICKEL



DESCRIPTION	CODE	SIZE	FINISH
CONNECTING SCREW 5 MM	499.040.27.0025	32 X 5	NICKLE



ENVIRONMENTAL MANAGEMENT

Grass pursues the goal of preventing or reducing environmental impacts at their very source. This means adopting an integrated approach to the product, considering all aspects from the initial product idea, through production and use to disposal.

GRASS ENVIRONMENTAL PRINCIPLES

- We see environmental protection as a major corporate objective, alongside business success, the quality of our products and occupational health & safety.
- We strive to conserve energy, water and resources in all our production processes and associated operations. In addition, we investigate and evaluate direct and indirect environmental impacts on a regular basis.
- We aim to use ecologically sound raw materials, consumables and supplies. We also look for savings potentials in the area of storage and packing. The multiple use system already in place is to be continuously expanded. Furthermore, we are looking for an economically and ecologically acceptable handling system.
- We continually develop cost-effective solutions and employ the state of the art in order to develop products with minimum environmental impact. We actively encourage the recycling of our products and provide the necessary product information for this purpose.
- In all our decisions regarding investment projects and the development of new products and manufacturing processes we take ecological criteria into account and, in so doing, operate a continuous improvement process for our environmental performance.
- We are committed to complying with all environmental requirements, laws and regulations, and underline the necessity for international harmonisation of environmental protection legislation.

 **G*GRASS®**



Grass ZA (Pty) Ltd.
2 Graph Avenue
Montague Gardens 7441
Cape Town,
South Africa
Phone +27 21 529 8040
Fax +27 21 529 8041
E-mail info@grass.co.za

Unit 6, Northlands Retail Park
Epsom Road
North Riding
Johannesburg 2169
South Africa

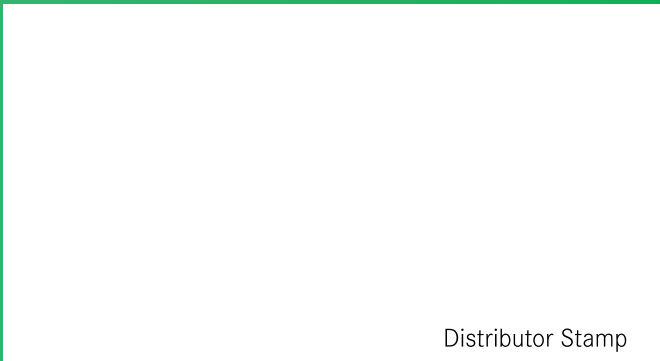

Distributor Stamp

www.grass.co.za